



# Molded Case Circuit Breaker Specifications

Bulletin 140UT

Topic	Page
Product Overview	2
Cat. No. Explanation	2
Product Selection	3
Accessories	4
Specifications	9
Approximate Dimensions	14
Additional Resources	17

## Product Overview

The Bulletin 140UT-D Molded Case Circuit Breaker (MCCB) UL489 and IEC 60947-2 Listed circuit breaker for global applications. The current-limiting circuit breaker provides fixed short-circuit and overcurrent protection and offers high interrupting ratings for 2- and 3-pole devices. These are also suitable for backfeeding.

Accessories are designed to be field installed. The compact busbars and feeder blocks reduce wiring errors and installation cost. Connection modules for 100-C contactors simplify wiring and can reduce the number of DIN Rails required, reducing panel space even further.



## Product Applications

- Feeder Circuits
  - Small cabinets
  - Distribution panels
  - Branch circuit protection
  - Transformers
  - Heaters
- Control Circuits
  - Control Transformers
  - Power supplies
- Heating, air conditioning and refrigeration (HACR)
- High-intensity discharge
- Switching duty (SWD) 15 and 20 A

## Cat. No. Explanation

140UT
-
D
7
-
D2
-
B60

a
b
c
d
e

a	
Bulletin Number	
Code	Description
140UT	140UT Molded Case Circuit Breaker (UL 489)

b	
Current Rating/ Frame Size	
Code	Description
D	40 A, Frame D

c	
Interrupting Rating/ Breaking Capacity	
Code	Description
7	UL 489

d	
Function	
Code	Description
D2	Fixed Thermal/Fixed Magnetic (15...20x I <sub>n</sub> ), 2-pole
D3	Fixed Thermal/Fixed Magnetic (15...20x I <sub>n</sub> ), 3-pole

e	
Current Range	
Code	Description
A	0.10 (example: A16 = 0.16 A)
B	1.0 (example: B16 = 1.6 A)
C	10 (example: C16 = 16 A)

# Product Selection

**Table 1 - 2-Pole Thermal-magnetic MCCBs, Fixed Thermal-Fixed Magnetic**

Rated Current $I_n$ [A]	Rated Magnetic Tripping Current	Rated Ultimate Short-circuit Breaking Capacity $I_{cu}$ [kA]				Rated Service Short-circuit Breaking Capacity $I_{cs}$ [kA]				Interrupting Rating, Max RMS Symmetrical [kA]			Cat. No.
		230/240V	400/415V	500/525V	690V	230/240V	400/415V	500/525V	690V	240V	480Y/277V	600Y/347V	
0.5	15...20 x $I_n$	100	100	65	50	100	65	65	50	100	100	50	140UT-D7D2-A50
1.0	15...20 x $I_n$	100	100	65	50	100	65	65	50	100	100	50	140UT-D7D2-B10
2.0	15...20 x $I_n$	100	100	65	18	100	65	65	10	100	100	50	140UT-D7D2-B20
3.0	15...20 x $I_n$	100	100	65	18	100	65	65	10	100	100	50	140UT-D7D2-B30
4.0	15...20 x $I_n$	100	100	65	18	100	65	65	10	100	100	50	140UT-D7D2-B40
5.0	15...20 x $I_n$	100	100	65	18	100	65	65	10	100	100	50	140UT-D7D2-B50
6.0	15...20 x $I_n$	100	100	65	18	100	65	65	10	100	100	50	140UT-D7D2-B60
8.0	15...20 x $I_n$	100	100	65	10	100	65	65	6	100	100	50	140UT-D7D2-B80
10	15...20 x $I_n$	100	100	65	10	100	65	65	6	100	100	50	140UT-D7D2-C10
12	15...20 x $I_n$	100	65	65	10	100	50	50	6	65	65	25	140UT-D7D2-C12
15	15...20 x $I_n$	100	65	65	10	100	50	50	6	65	65	25	140UT-D7D2-C15
20	15...20 x $I_n$	100	65	65	10	100	50	50	6	65	65	—	140UT-D7D2-C20
25	15...20 x $I_n$	100	65	65	10	100	50	25	6	65	65	—	140UT-D7D2-C25
30	15...20 x $I_n$	100	65	65	10	100	50	25	6	65	65	—	140UT-D7D2-C30
35	14 x $I_n$	100	65	65	10	100	50	25	6	65	65	—	140UT-D7D2-C35
40	12 x $I_n$	100	65	65	10	100	50	25	6	65	65	—	140UT-D7D2-C40

**Table 2 - 3-Pole Thermal-magnetic MCCBs, Fixed Thermal-Fixed Magnetic**

Rated Current $I_n$ [A]	Rated Magnetic Tripping Current	Rated Ultimate Short-circuit Breaking Capacity $I_{cu}$ [kA]				Rated Service Short-circuit Breaking Capacity $I_{cs}$ [kA]				Interrupting Rating, Max RMS Symmetrical [kA]			Cat. No.
		230/240V	400/415V	500/525V	690V	230/240V	400/415V	500/525V	690V	240V	480Y/277V	600Y/347V	
0.5	15...20 x $I_n$	100	100	65	50	100	65	65	50	100	100	50	140UT-D7D3-A50
1.0	15...20 x $I_n$	100	100	65	50	100	65	65	50	100	100	50	140UT-D7D3-B10
2.0	15...20 x $I_n$	100	100	65	18	100	65	65	10	100	100	50	140UT-D7D3-B20
3.0	15...20 x $I_n$	100	100	65	18	100	65	65	10	100	100	50	140UT-D7D3-B30
4.0	15...20 x $I_n$	100	100	65	18	100	65	65	10	100	100	50	140UT-D7D3-B40
5.0	15...20 x $I_n$	100	100	65	18	100	65	65	10	100	100	50	140UT-D7D3-B50
6.0	15...20 x $I_n$	100	100	65	18	100	65	65	10	100	100	50	140UT-D7D3-B60
8.0	15...20 x $I_n$	100	100	65	10	100	65	65	6	100	100	50	140UT-D7D3-B80
10	15...20 x $I_n$	100	100	65	10	100	65	65	6	100	100	50	140UT-D7D3-C10
12	15...20 x $I_n$	100	65	65	10	100	50	50	6	65	65	25	140UT-D7D3-C12
15	15...20 x $I_n$	100	65	65	10	100	50	50	6	65	65	25	140UT-D7D3-C15
20	15...20 x $I_n$	100	65	65	10	100	50	50	6	65	65	—	140UT-D7D3-C20
25	15...20 x $I_n$	100	65	65	10	100	50	25	6	65	65	—	140UT-D7D3-C25
30	15...20 x $I_n$	100	65	65	10	100	50	25	6	65	65	—	140UT-D7D3-C30
35	14 x $I_n$	100	65	65	10	100	50	25	6	65	65	—	140UT-D7D3-C35
40	12 x $I_n$	100	65	65	10	100	50	25	6	65	65	—	140UT-D7D3-C40

# Accessories

## Auxiliary Contacts

Description	Operator Position <sup>(1)</sup>			Term. No.	Contact Description	Connection Diagram <sup>(2)</sup>	For Use With	Cat. No.
	OFF	ON	Tripped					
 Front-Mounted Auxiliary Contact • 1-pole or 2-pole • No additional space required • Only one per device	0	X	0	13-14	N.O. Aux		140MT-C, D 140UT-D	140MT-C-AFA10
	0	X	0	13-14	N.O. Aux		140MT-C, D 140UT-D	140MT-C-AFA11
	X	0	X	21-22	N.C. Aux			
 Right Side-Mounted Auxiliary Contact • 2-pole • Adds 9 mm to the width of the device • One per device • Not suitable for UL 489 applications	0	X	0	13-14	N.O. Aux		140MT-C, D 140UT-D	140MT-C-AFA20
	0	X	0	23-24	N.O. Aux			
	0	X	0	33-34	N.O. Aux		140MT-C, D 140UT-D	140MT-C-ASA20
	0	X	0	43-44	N.O. Aux			
	X	0	X	31-32	N.C. Aux		140MT-C, D 140UT-D	140MT-C-ASA02
	X	0	X	41-42	N.C. Aux			
0	X	0	33-34	N.O. Aux		140MT-C, D 140UT-D	140MT-C-ASA11	
X	0	X	41-42	N.C. Aux				

(1) X = Contact Closed; 0 = Contact Open

(2) Connection Diagram Reference:

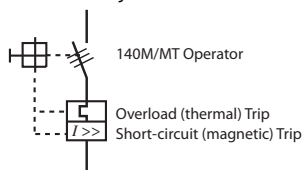

### Trip Contacts

Description	Operator Position <sup>(1)</sup>			Term. No.	Contact Description	Connection Diagram <sup>(2)</sup>	For Use With	Cat. No.
	OFF	ON	Tripped					
 <p>Front-Mounted Trip Contact</p> <ul style="list-style-type: none"> <li>• 2-pole</li> <li>• Indicates tripping of device</li> <li>• No additional space required</li> </ul>	0	X	0	13-14	N.O. Aux		140MT-C, D 140UT-D	140MT-C-AFAR10A10
	0	0	X	27-28	N.O. Trip (short-circuit and overload)			
	X	0	X	11-12	N.C. Aux		140MT-C, D 140UT-D	140MT-C-AFAR10A01
	0	0	X	27-28	N.O. Trip (short-circuit and overload)			
	0	X	0	13-14	N.O. Aux		140MT-C, D 140UT-D	140MT-C-AFAR01A10
	X	X	0	25-26	N.C. Trip (short-circuit and overload)			
	0	0	X	17-18	N.O. Trip (short-circuit and overload)		140MT-C, D 140UT-D	140MT-C-AFAR10M10
	0	0	X	27-28	N.O. Trip (short-circuit)			

(1) X = Contact Closed; 0 = Contact Open

(2) Connection Diagram Reference:

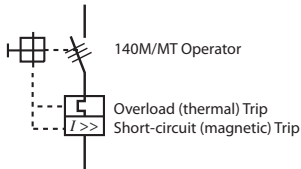

### Undervoltage Trip Units

Description	Connection Diagram <sup>(1)</sup>	Trip Rating	For Use With	Cat. No.
 <p>Undervoltage Trip</p> <ul style="list-style-type: none"> <li>• Left-side mounted</li> <li>• Adds 18 mm to the width of the device</li> <li>• Automatically trips MPCB/MCP when voltage falls below 35...70%</li> </ul>		24V, 50 Hz/24...28V, 60 Hz	140MT-C, D 140UT-D (UL 489 applications up to 30 A)	140MT-C-UXK
		110V, 50 Hz; 120V, 60 Hz		140MT-C-UXD
		220...230V, 50 Hz		140MT-C-UXF
		240...260V, 60 Hz		140MT-C-UXA
		380...400V, 50 Hz		140MT-C-UXN
		480V, 60 Hz/415V, 50 Hz		140MT-C-UXB

(1) Connection Diagram Reference:

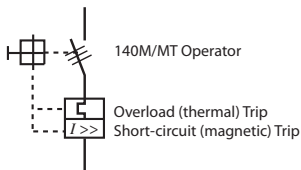



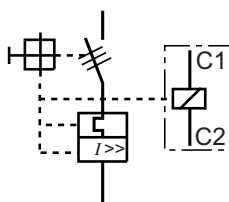

### Shunt Trip Units

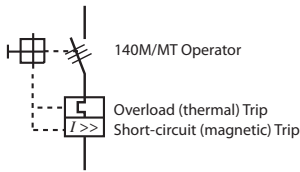
Description	Connection Diagram <sup>(1)</sup>	Trip Rating	For Use With	Cat. No.
 <p>Shunt Trip</p> <ul style="list-style-type: none"> <li>• Left-side mounted</li> <li>• Adds 18 mm to the width of the device</li> <li>• Provides remote tripping of the MPCB/MCP</li> <li>• Maximum on time for DC operated devices: 5 sec.</li> </ul>		24V, 50 Hz/24...28V, 60 Hz	140MT-C, D 140UT-D (UL 489 applications up to 30 A)	140MT-C-SNK
		110V, 50 Hz/120V, 60 Hz		140MT-C-SND
		220...230V, 50 Hz		140MT-C-SNF
		240...260V, 60 Hz		140MT-C-SNA
		240V, 50 Hz; 277V, 60 Hz		140MT-C-SNT
		380...400V, 50 Hz		140MT-C-SNN
		480V, 60 Hz/415V, 50 Hz		140MT-C-SNB
24V DC	140MT-C-SNZJ			







(1) Connection Diagram Reference:



### Additional Accessories

Description	For Use With	Cat. No.	
 <p>Anti-Tamper Shield</p> <ul style="list-style-type: none"> <li>• Provides protection against inadvertent adjustment of the current setting</li> <li>• Must be ordered in multiples of 10 (10 pieces/package)</li> </ul>	140MT-C, D	140MT-C-CA	
 <p>Lockable Twist Knob</p> <ul style="list-style-type: none"> <li>• For one padlock 5 mm (3/16 in.) diameter shackle</li> <li>• Can be locked in OFF position</li> </ul>	Blue	140MT-C-KB	
	Black	140MT-C, D 140UT-D	140MT-C-KN
	Red/Yellow	140MT-C-KRY	
 <p>Locking Tag</p> <ul style="list-style-type: none"> <li>• Padlock attachment to the lockable handles</li> <li>• Up to three padlocks 4...8 mm (5/16 in.) diameter shackle</li> </ul>	140MT-C-KN1 140MT-C-KRY1	140MT-C-M3	
 <p>Door Coupling Handle</p> <ul style="list-style-type: none"> <li>• For 3 padlocks 4...8 mm (5/16 in.) in diameter</li> <li>• IP66 Protection/Type 1, 4, 4X, 12 Interlock override capability</li> <li>• Can be modified for locking in ON position</li> <li>• Ships with coupling – order extension shaft and legend plate separately</li> </ul>	Black	140MT-C, D 140UT-D	140MT-C-DN66
	Red/Yellow	140MT-C, D 140UT-D	140MT-C-DRY66



**Additional Accessories (Continued)**

	Description	For Use With	Cat. No.
	Extension Shaft (Short length) <ul style="list-style-type: none"> <li>Cut to required length for mounting depth (front of DIN Rail to front of enclosure door)</li> <li>140MT-C: 136 mm (5.35 in.)</li> <li>140MT-D: 143 mm (5.63 in.)</li> <li>140UT-D: 143 mm (5.63 in.)</li> <li>For Cat. Nos. 140MT-C-DN66 and 140MT-C-DRY66 handles</li> </ul>	140MT-C, D 140UT- D	140MT-C-DSS
	Extension Shaft (Standard length) <ul style="list-style-type: none"> <li>Cut to required length for mounting depth (front of DIN Rail to front of enclosure door)</li> <li>140MT-C: 136...358 mm (5.35...14.1 in.)</li> <li>140MT-D: 143...364 mm (5.63...14.33 in.)</li> <li>140UT-D: 143...364 mm (5.63...14.33 in.)</li> <li>For Cat. Nos. 140MT-C-DN66 and 140MT-C-DRY66 handles</li> </ul>		140MT-C-DS
	Extension Shaft (Extended length) <ul style="list-style-type: none"> <li>Cut to required length for mounting depth (front of DIN Rail to front of enclosure door)</li> <li>140MT-C: 136...507 mm (5.35...19.96 in.)</li> <li>140MT-D: 143...513 mm (5.63...20.2 in.)</li> <li>140UT-D: 143...513 mm (5.63...20.2 in.)</li> <li>For Cat. Nos. 140MT-C-DN66 and 140MT-C-DRY66 handles</li> </ul>		140MT-C-DSL
	Door Coupling Handle <ul style="list-style-type: none"> <li>Type 3, 3R, 4, 4X, 12 (IP66)</li> <li>For up to 2 padlocks</li> <li>Fits in 30.5 mm cutout</li> <li>Requires 140MT-C-DNC (140MT-C, 140MT-D, 140UT-D) or 140M-C-DNC (140M-F) coupler</li> </ul>	Black	140MT-C, D 140UT- D 140MT-SB
		Red/Yellow	140MT-C, D 140UT- D 140MT-SY
	Extension Shaft <ul style="list-style-type: none"> <li>Cut to required length for mounting depth (front of DIN Rail to front of enclosure door)</li> </ul>	12 in. (30.48 cm)	140MT-SB, 140MT-SY 140MT-S1
		21 in. (53.34 cm)	140MT-SB, 140MT-SY 140MT-S2
	Coupler <ul style="list-style-type: none"> <li>Included with Cat. Nos. 140MT-C-DN66 and 140MT-C-DRY66</li> </ul>	140MT-C, D 140UT- D	140MT-C-DNC
	Extension Shaft Support <ul style="list-style-type: none"> <li>Provides consistent alignment of the 140M/MT-C-DS and 140M/MT-C-DSL shafts with the 140M/MT-C-DN66 or 140M/MT-C-DRY66 door coupling handles</li> <li>Recommended for shaft lengths &gt;200 mm</li> <li>Snaps on the right side of the 140MT-C, -D, 140M-F, or 140UT-D device and allows the addition of one side-mounted auxiliary contact.</li> <li>Width: 9 mm.</li> <li>For use with screw-mounted or hat rail mounted devices.</li> </ul>	140MT-C, D 140UT- D	140MT-C-SHS
	Legend Plate	Marking: "Hauptschalter" and "Main Switch"	140MT-C-DN66 140MT-C-DFCN
		Marking: "Not-Aus" and "Emergency Off"	140MT-C-DRY66 140M-C-DRY66 140MT-C-DFCRY
	Screw Adapter <ul style="list-style-type: none"> <li>For screw arrangement of a motor protection circuit breaker</li> <li>Must be ordered in multiples of 10 (10 pieces/pkg)</li> </ul>	140MT-C, D 140UT- D	140MT-C-N45

**Modules and Adapters**

	Description	For Use With	Cat. No.
	ECO Connecting Modules – 25 A (IEC), 22 A (UL) <ul style="list-style-type: none"> <li>Eco-starters mount on single DIN Rail</li> <li>Electrical and mechanical interconnection of 140UT MPCB and 100-C</li> </ul>	140UT-D7D3 to 100-C09...C23	140UT-D-PEC23

**Other Accessories**

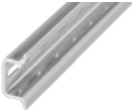
	Description	For Use With	Cat. No.								
	Feeder Terminal for Compact Busbar – 64 A Max Continuous Current	14OUT-D-W	14OUT-D-WTE								
	Three-phase Compact Busbar for MPCBs – 64 A Max Continuous Current • 45 mm (1.77 in.) spacing	<table border="1"> <tr><td>2 connections</td></tr> <tr><td>3 connections</td></tr> <tr><td>4 connections</td></tr> <tr><td>5 connections</td></tr> </table>	2 connections	3 connections	4 connections	5 connections	<table border="1"> <tr><td>14OUT-D-W452</td></tr> <tr><td>14OUT-D-W453</td></tr> <tr><td>14OUT-D-W454</td></tr> <tr><td>14OUT-D-W455</td></tr> </table>	14OUT-D-W452	14OUT-D-W453	14OUT-D-W454	14OUT-D-W455
2 connections											
3 connections											
4 connections											
5 connections											
14OUT-D-W452											
14OUT-D-W453											
14OUT-D-W454											
14OUT-D-W455											
	DIN (#3) symmetrical hat rail • 35 mm x 7.5 mm x 1 m (1.4 x 0.3 x 39 in.) long • 10 pieces/package	14OUT-D	199-DR1								
	DIN (#3) Symmetrical Rail • 35 mm x 15 mm x 1 m (1.4 x 0.6 x 39 in.) long • Top Hat Rail (DIN #3 Symmetrical Rail) • 5 pieces/package	14OUT-D	1492-DR9								











# Specifications



**Table 3 - General Data**

Attribute			140UT
No. of Poles			2 and 3
Rated Insulation Voltage $U_i$		IEC	690
		UL/CSA	690
Minimum Enclosure Size	0.5...12 A Devices	Suitable for continuous operation at <b>100%</b> of rating only if used in min enclosure space:	250 x 175 x 150 mm (10 x 7 x 6 in.)
			300 x 175 x 150 mm (11.8 x 7 x 6 in.)
	15...40 A Devices	Suitable for continuous operation at <b>80%</b> of rating only if used in min enclosure space:	250 x 175 x 150 mm (10 x 7 x 6 in.)
			300 x 175 x 150 mm (11.8 x 7 x 6 in.)
Rated Impulse Withstand Voltage $U_{imp}$		Pollution degree	3
		Main circuits $U_{imp}$ /Overvoltage Category	6 kV/III
		Auxiliary circuits $U_{imp}$ /Overvoltage Category	6 kV/III
		Safe separation between main and auxiliary circuits	up to 400V
Rated Frequency		[Hz]	50/60
Utilization Category		IEC 60947-2 (Circuit breaker)	A
Life Span		Mechanical	100 000
		Electrical ( $I_g$ max.)	10 000
		Switching Frequency	max. 25
Ambient Temperature		Storage	-40...+80
		Operation	-25...+60 (70 with 15% $I_n$ current reduction) (-13...+140 °F [+158 with 15% $I_n$ current reduction])
Climatic resistance		Moisture change climate (600068-2-30)	23 °C (73 °F)/83% relative humidity and 40 °C (104 °F)/92% relative humidity, 56 cycles
		Dry heat (60086-2-2)	100 °C (212 °F), relative humidity < 50%, 7 days
		Moisture heat (60068-2-3)	40 °C (104 °F), relative humidity 93%, 56 days
Site Altitude		[m]	up to 2000 N.N. (6561 ft)
Protection Class			IP2X when wired
Resistance to Shock, Transport (60068-2-27)			30G, 11 ms, all axes
Resistance to Vibration, Operation (60068-2-6)			18 G
Overload Protection Characteristics			Yes per IEC/EN 60947-2, UL489, CSA 22.2
Ambient Temperature Compensation		[ °C ( °F)]	-25...+60 (-13...+140)
Phase-loss Protection			No
Short-circuit protection (Magnetic)			fixed setting 15...20 x $I_n$ , (35 A - 14 x $I_n$ and 40 A - 12 x $I_n$ )
Backfeeding			Suitable for backfeeding up to 480Y/277V and 600Y/347V
Total Power loss $P_v$		at $I_n$ max	[W] 7.5
Main Disconnect Switch Application			Yes, with accessories
HID (High Intensity Discharge) Listed			0.5...40 A
Switching Duty			15 A, 20 A
Heating, air conditioning and refrigeration (HACR)			0.5...40 A
Application Conditions		For utilization outside North America, assemblies (of products) shall comply to the IEC 61439-1 requirements	
		140UT MCCBs are intended for use in closed areas without hazardous operating conditions such as dust or explosive or corrosive gases. Enclosures of appropriate manner need to be in place to protect devices in such environments.	
Standards Compliance			UL489; CSA C22.2 No. 5; IEC / EN 60947-1, -2
Certifications			CE; cULus Listed Circuit Breaker

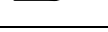
**Table 4 - MCCB Connecting Characteristics**

Connection		No. of Conductors	14OUT ≤ 15 A	14OUT > 15 A
Type of terminals				
			Screw Clamp up to 16 A, M4	Screw Clamp > 16 A, M4
Connection Screw			Pozidriv No. 2/Blade No. 3	Pozidriv No. 2/Blade No. 3
Wiring	Solid or stranded	 1	1...6 mm <sup>2</sup>	1.5...10 mm <sup>2</sup>
		 2	1...2.5 mm <sup>2</sup> 2.5...6 mm <sup>2</sup>	1.5...4 mm <sup>2</sup> 4...10 mm <sup>2</sup>
	Flexible with ferrule (end sleeve)	 1	1...6 mm <sup>2</sup>	1.5...10 mm <sup>2</sup>
		 2	1...2.5 mm <sup>2</sup> 2.5...4 mm <sup>2</sup>	1.5...4 mm <sup>2</sup> 4...10 mm <sup>2</sup>
	Finely stranded	 1	1.5...6 mm <sup>2</sup>	2.5...10 mm <sup>2</sup>
		 2	1.5...4 mm <sup>2</sup> 2.5...6 mm <sup>2</sup>	2.5...6 mm <sup>2</sup> 4...10 mm <sup>2</sup>
	Cross section per UL/CSA solid, stranded	 1	No. 14...10 AWG	No. 14...8 AWG
		 2	No. 14...10 AWG	No. 14...10 AWG No. 12...8 AWG
Stripping length (De-isolation length)			10 mm (0.39 in.)	10 mm (0.39 in.)
Tightening torques		[N•m]	2...2.5	2...2.5
		[lb•in]	18...22	18...22

**Table 5 - Cat. No. 14OUT-D-WTE Feeder Terminal Connecting Characteristics;  $I_{th} = 65 A, 60\text{ }^{\circ}C (140\text{ }^{\circ}F)$**

Connection		No. of Conductors	14OUT-WTE
Conductor Type			D Frame
Type of terminals			Box lugs
Connection Screw			Pozidriv No. 2/Blade No. 4
Wiring	Solid or stranded	 1	2.5...25 mm <sup>2</sup> , 14...4 AWG
	Flexible with ferrule (end sleeve)	 1	2.5...25 mm <sup>2</sup> , 14...4 AWG
	Stripping length (De-isolation length)		
Tightening torques		[N•m]	3...3.5
		[lb•in]	27...31

## Accessory Specifications

**Table 6 - Auxiliary Contact Specifications**





Attribute			Front-mounted Auxiliary Contacts Cat. Nos. 140MT-C-AFA, -AFAR/ -AFAR10M10	
Rated Thermal Current $I_{th}$	at 40 °C (104 °F) ambient temperature	[A]	5	
	at 60 °C (140 °F) ambient temperature	[A]	4	
Back-up Fuses gG, gL		[A]	10	
General Use current		[A]	5	
Rated insulation voltage $U_i$	IEC	[V]	250	
	UL/CSA	[V]	240	
Contact rating code designation (UL/CSA)		AC	B300	
		DC	R300	
Rated Supply Current $I_e$	AC-15	24V	[A]	4
		120V	[A]	3
		240V	[A]	1.5
		415V	[A]	
		690V	[A]	
	DC-13	24V	[A]	1.2
		125V	[A]	0.22
		250V	[A]	0.11
		400V	[A]	–
		500V	[A]	–
Type of Terminals				
Recommended screwdriver			Pozidriv No. 2 / Blade No.3	
Flexible with insulated ferrule		1 or 2 conductors	0.5...1.5 mm <sup>2</sup> / No. 18...14 AWG	
Flexible		1 or 2 conductors	0.5...1.5 mm <sup>2</sup> / No. 18...14 AWG	
Stranded per UL/CSA		1 or 2 conductors	0.5...1.5 mm <sup>2</sup> / No. 18...14 AWG	
Solid		1 or 2 conductors	0.5...1.5 mm <sup>2</sup> / No. 18...14 AWG	
Conductor steps			Max 2 conductor steps allowed	
Tightening torque			1...1.2 N•m/8.9...10.6 lb•in	

Table 7 - Undervoltage and Shunt Trip Specifications

Attribute				Undervoltage Trip for Left-side Mounting Cat. No. 140MT-C-UX	Shunt Trip for Left-side Mounting Cat. No. 140MT-C-SN	
Actuating Voltage	Pick-up		[V]	$0.85...1.1 \times U_s$	$0.7...1.1 \times U_s$	
	Drop-out		[V]	$0.7...0.35 \times U_s$	$0.7...1.1 \times U_s$	
Rated AC Control Voltage	140MT-C-UXK	50 Hz	[V AC]	24	—	
		60 Hz	[V AC]	28	—	
	140MT-C-UXD	50 Hz	[V AC]	110	—	
		60 Hz	[V AC]	120	—	
	140MT-C-UXF	50 Hz	[V AC]	220...230	—	
		60 Hz	[V AC]	—	—	
	140MT-C-UXA	50 Hz	[V AC]	—	—	
		60 Hz	[V AC]	240...260	—	
	140MT-C-UXN	50 Hz	[V AC]	380...400	—	
		60 Hz	[V AC]	440...460	—	
	140MT-C-UXB	50 Hz	[V AC]	415	—	
		60 Hz	[V AC]	480	—	
	140MT-C-SNK	50 Hz	[V AC]	—	24	
		60 Hz	[V AC]	—	24...28	
	140MT-C-SND	50 Hz	[V AC]	—	110	
		60 Hz	[V AC]	—	120	
	140MT-C-SNF	50 Hz	[V AC]	—	220...230	
		60 Hz	[V AC]	—	—	
	140MT-C-SNA	50 Hz	[V AC]	—	—	
		60 Hz	[V AC]	—	240...260	
	140MT-C-SNT	50 Hz	[V AC]	—	240	
		60 Hz	[V AC]	—	277	
	140MT-C-SNN	50 Hz	[V AC]	—	380...400	
		60 Hz	[V AC]	—	440...460	
	140MT-C-SNB	50 Hz	[V AC]	—	415	
		60 Hz	[V AC]	—	480	
	On-time				Continuous duty	Continuous duty
	Coil consumption	Pick-up	[VA/W]	8.5/8	8.5/8	
		Hold-in	[VA/W]	4/2	4/2	
	Rated DC Control Voltage	140MT-C-SNZJ		[V DC]	—	24
		On-time				Max 5 s
	Coil consumption	Pick-up	[W]		50	
Type of Terminals						
Recommended screwdriver				Pozidriv No. 2 / Blade No.3	Pozidriv No. 2 / Blade No.3	
Flexible with insulated ferrule		1 or 2 conductors	$0.5...2.5 \text{ mm}^2 / \text{No. } 18...14 \text{ AWG}$	$0.5...2.5 \text{ mm}^2 / \text{No. } 18...14 \text{ AWG}$		
Flexible		1 or 2 conductors	$0.75...2.5 \text{ mm}^2 / \text{No. } 18...14 \text{ AWG}$	$0.75...2.5 \text{ mm}^2 / \text{No. } 18...14 \text{ AWG}$		
Stranded per UL/CSA		1 or 2 conductors	$0.75...2.5 \text{ mm}^2 / \text{No. } 18...14 \text{ AWG}$	$0.75...2.5 \text{ mm}^2 / \text{No. } 18...14 \text{ AWG}$		
Solid		1 or 2 conductors	$0.5...2.5 \text{ mm}^2 / \text{No. } 18...14 \text{ AWG}$	$0.5...2.5 \text{ mm}^2 / \text{No. } 18...14 \text{ AWG}$		
Conductor steps				Max 2 conductor steps allowed	Max 2 conductor steps allowed	
Tightening torque				$1...1.2 \text{ N}\cdot\text{m} / 8.9...10.6 \text{ lb}\cdot\text{in}$	$1...1.2 \text{ N}\cdot\text{m} / 8.9...10.6 \text{ lb}\cdot\text{in} 1...1.2$	

# Time-Current Characteristic

Figure 1 - Molded Case Circuit Breaker Time-Current Characteristic

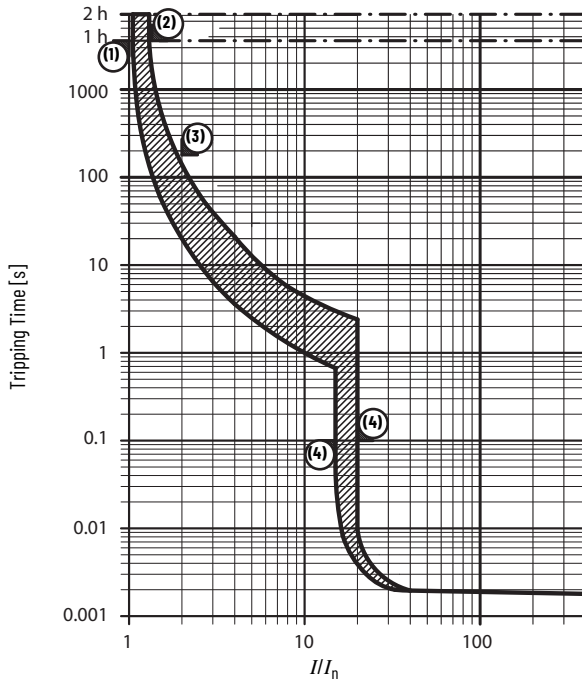

### Tripping Characteristic per UL 489 and IEC 60947-2

Note	Information
1	Conventional non-tripping current $I_{nt} = 1.0 \times I_n$
2	Conventional tripping current $I_t = 1.35 \times I_n$ ; $t < 1 \text{ h}$
3	$2.0 \times I_n$ ; $t = 180 \text{ s max}$

### Instantaneous Tripping per UL 489 and IEC 60947-2

Note	Information
4	Trip curve $15...20 \times I_n$

# Approximate Dimensions

Figure 2 - Mounting Position and Spacing Requirements

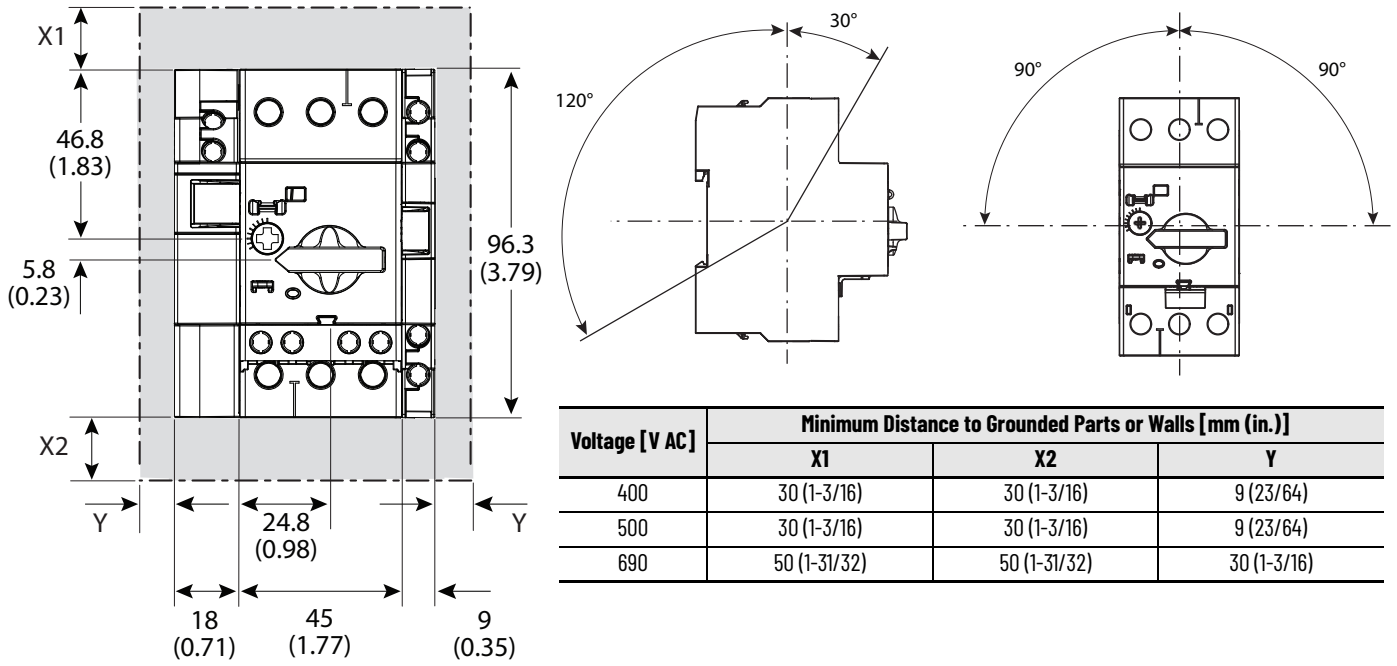
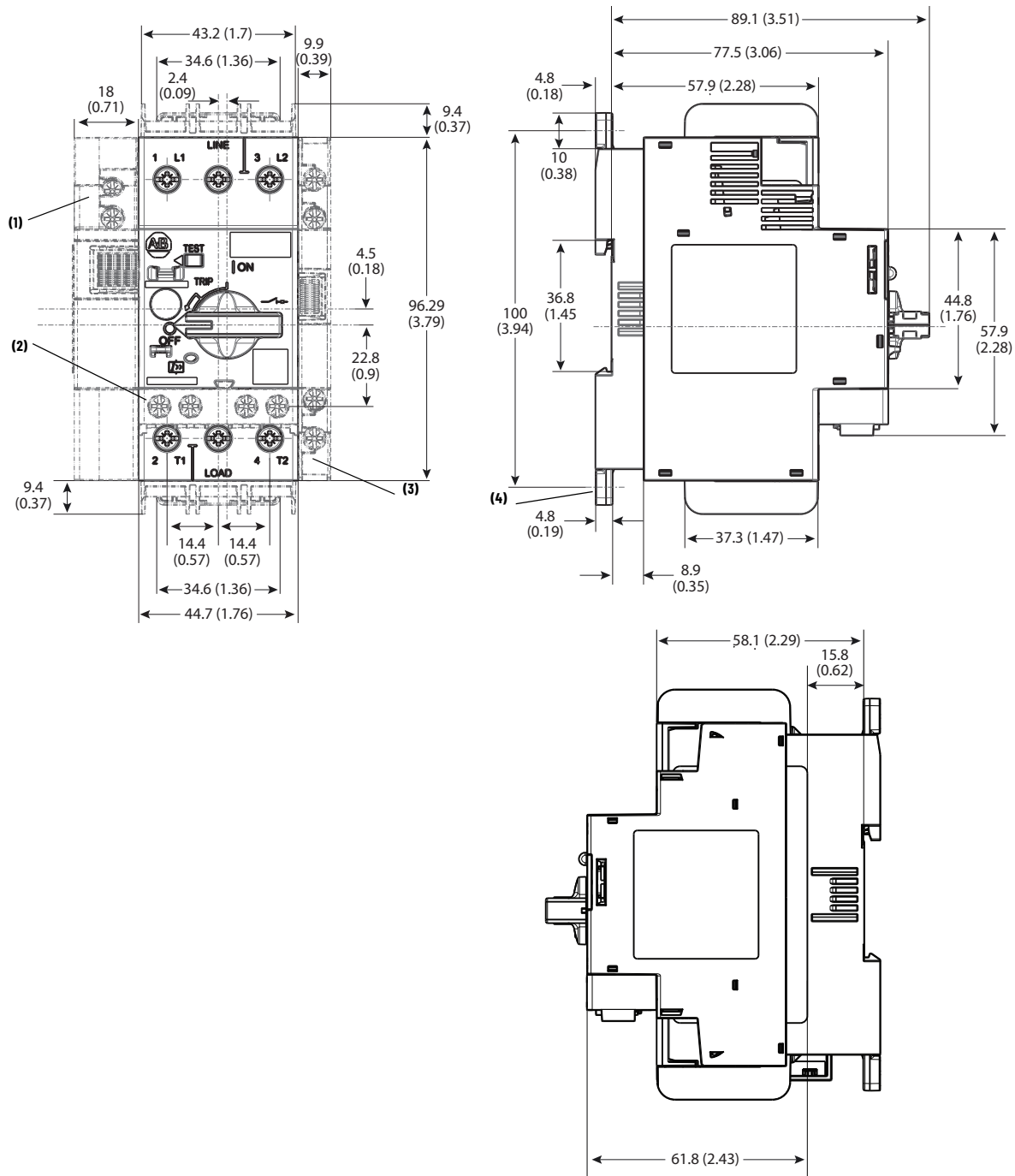

Figure 3 - Molded Case Circuit Breaker, Cat. No. 140UT-D7...



Note	Information
1	Undervoltage/shunt trip
2	Auxiliary contact (front mounted)
3	Auxiliary contact (side mounted) Do not use for UL 489 applications
4	Screw mounting adapter

**Notes:**



## Additional Resources

These documents contain additional information concerning related products from Rockwell Automation.

Resource	Description
Motor Protection Circuit Breaker and Motor Circuit Protector Specifications, publication <a href="#">140-TD005</a>	Provides product selection and specification information for Bulletin 140MP/MT motor protection circuit breakers and motor circuit protectors.
Molded Case Circuit Breaker Selectivity Guide, publication <a href="#">140G-TD050</a>	Aids in selecting circuit breaker pairs for line and load side protection.
Short-circuit Current Ratings and Your Industrial Control Panel, publication <a href="#">SCCR-AT002</a>	Provides examples for short-circuit current ratings of panels based on the methods stated in UL 508A Supplement B.
Global Short-circuit Rating Tool, <a href="http://rok.auto/sccr">rok.auto/sccr</a>	Provides coordinated high-fault branch circuit solutions for motor starters, soft starters, and component drives.
UL Standards Listing for Industrial Control Products, publication <a href="#">CMPNTS-SR002</a>	Assists original equipment manufacturers (OEMs) with construction of panels, to help ensure that they conform to the requirements of Underwriters Laboratories.
American Standards, Configurations, and Ratings: Introduction to Motor Circuit Design, publication <a href="#">IC-AT001</a>	Provides an overview of American motor circuit design based on methods that are outlined in the NEC.
Industrial Components Preventive Maintenance, Enclosures, and Contact Ratings Specifications, publication <a href="#">IC-TD002</a>	Provides a quick reference tool for Allen-Bradley industrial automation controls and assemblies.
Safety Guidelines for the Application, Installation, and Maintenance of Solid-state Control, publication <a href="#">SGI-1.1</a>	Designed to harmonize with NEMA Standards Publication No. ICS 1.1-1987 and provides general guidelines for the application, installation, and maintenance of solid-state control in the form of individual devices or packaged assemblies incorporating solid-state components.
Industrial Automation Wiring and Grounding Guidelines, publication <a href="#">1770-4.1</a>	Provides general guidelines for installing a Rockwell Automation industrial system.
Product Certifications website, <a href="http://rok.auto/certifications">rok.auto/certifications</a> .	Provides declarations of conformity, certificates, and other certification details.

You can view or download publications at [rok.auto/literature](http://rok.auto/literature).

# Rockwell Automation Support

Use these resources to access support information.

<b>Technical Support Center</b>	Find help with how-to videos, FAQs, chat, user forums, and product notification updates.	<a href="http://rok.auto/support">rok.auto/support</a>
<b>Knowledgebase</b>	Access Knowledgebase articles.	<a href="http://rok.auto/knowledgebase">rok.auto/knowledgebase</a>
<b>Local Technical Support Phone Numbers</b>	Locate the telephone number for your country.	<a href="http://rok.auto/phonesupport">rok.auto/phonesupport</a>
<b>Literature Library</b>	Find installation instructions, manuals, brochures, and technical data publications.	<a href="http://rok.auto/literature">rok.auto/literature</a>
<b>Product Compatibility and Download Center (PCDC)</b>	Download firmware, associated files (such as AOP, EDS, and DTM), and access product release notes.	<a href="http://rok.auto/pcdc">rok.auto/pcdc</a>





## Documentation Feedback

Your comments help us serve your documentation needs better. If you have any suggestions on how to improve our content, complete the form at [rok.auto/docfeedback](http://rok.auto/docfeedback).

Allen-Bradley, expanding human possibility, and Rockwell Automation are trademarks of Rockwell Automation, Inc.  
Trademarks not belonging to Rockwell Automation are property of their respective companies.

Rockwell Automation maintains current product environmental compliance information on its website at [rok.auto/pec](http://rok.auto/pec).

Rockwell Otomasyon Ticaret A.Ş. Kar Plaza İş Merkezi E Blok Kat:6 34752, İçerenköy, İstanbul, Tel: +90 (216) 5698400 EEE Yönetmeliğine Uygundur

Connect with us.    

**rockwellautomation.com** ————— expanding **human possibility**<sup>™</sup>

AMERICAS: Rockwell Automation, 1201 South Second Street, Milwaukee, WI 53204-2496 USA, Tel: (1) 414.382.2000, Fax: (1) 414.382.4444

EUROPE/MIDDLE EAST/AFRICA: Rockwell Automation NV, Pegasus Park, De Kleetlaan 12a, 1831 Diegem, Belgium, Tel: (32) 2 663 0600, Fax: (32) 2 663 0640

ASIA PACIFIC: Rockwell Automation, Level 14, Core F, Cyberport 3, 100 Cyberport Road, Hong Kong, Tel: (852) 2887 4788, Fax: (852) 2508 1846